

IP 66



IK 09



- Plugs and sockets receptacles 16A to 63A, 12V to 690V
- All sockets incorporate switching technology that prevents removal of the plug under electrical load and does not disturb the potentially explosive atmospheres



CONSTRUCTION

Socket/ 2P - 2P+E - 3P: polycarbonate
 Socket / 3P+E - 3P+N+E: SMC
 Plug, mobile socket, flush socket: polyamide

TECHNICAL DATA

Certificate:	LCIE 02 ATEX 6068, LCIE 02 ATEX 0001U
Marking:	CE 50228
Apparatus category:	II 2G II 2D
Marking of explosion protection:	Ex de IIC T6 Ex tD A21 T68°C
Ambient temperature:	-40 °C ≤ T _{amb} ≤ +55°C
Degree of protection:	IP 66
Impact resistance:	IK09

Plug	
Wall socket	
Mobile socket	
Flush socket	



Plugs and sockets

MODEL CODE / 16A

Description	Pin Configuration	Weight kg (lb)	Volume dm ³ (in ³)	Catalog Number	
				IECEX	NBR
Low Voltage: LV					
100/130 Vac 50/60 Hz – Yellow					
Wall Socket		0.6 (1.3)	3.8 (231.89)	PRE316RY	NPRES16RY
Plug		0.2 (0.4)	0.6 (36.61)	PRE316PY	NPRES16PY
Mobile Socket		0.4 (0.9)	1.3 (79.33)	PRE316MY	NPRES16MY
Flush Socket		0.2 (0.4)	1.3 (79.33)	PRE316FY	NPRES16FY
200/250 Vac 50/60 Hz – Blue					
Wall Socket		0.6 (1.3)	3.8 (231.89)	PRE316RB	NPRES16RB
Plug		0.2 (0.4)	0.6 (36.61)	PRE316PB	NPRES16PB
Mobile Socket		0.4 (0.9)	1.3 (79.33)	PRE316MB	NPRES16MB
Flush Socket		0.2 (0.4)	1.3 (79.33)	PRE316FB	NPRES16FB
200/250 Vac 50/60 Hz – Blue					
Wall Socket		1.5 (3.3)	4.7 (286.81)	PRE416RB	NPRES16RB
Plug		0.6 (1.3)	0.6 (36.61)	PRE416PB	NPRES16PB
Mobile Socket		0.6 (1.3)	4.0 (244.09)	PRE416MB	NPRES16MB
Flush Socket		0.2 (0.4)	1.3 (79.33)	PRE416FB	NPRES16FB
Wall Socket		1.6 (3.5)	4.7 (286.81)	PRE516RB	NPRES16RB
Plug		0.3 (0.7)	1.3 (79.33)	PRE516PB	NPRES16PB
Mobile Socket		0.6 (1.3)	4.0 (244.09)	PRE516MB	NPRES16MB
Flush Socket		0.2 (0.4)	1.3 (79.33)	PRE516FB	NPRES16FB
<i>(1) 120/208 V - 144/250 Vac 50/60 Hz</i>					
380/415 Vac 50/60 Hz – Red					
Wall Socket		1.5 (3.3)	4.7 (286.81)	PRE416RR	NPRES16RR
Plug		0.2 (0.4)	0.6 (36.61)	PRE416PR	NPRES16PR
Mobile Socket		0.6 (1.3)	4.0 (244.09)	PRE416MR	NPRES16MR
Flush Socket		0.3 (0.7)	1.3 (79.33)	PRE416FR	NPRES16FR
Wall Socket		1.6 (3.5)	4.7 (286.81)	PRE516RR	NPRES16RR
Plug		0.3 (0.7)	1.3 (79.33)	PRE516PR	NPRES16PR
Mobile Socket		0.6 (1.3)	4.0 (244.09)	PRE516MR	NPRES16MR
Flush Socket		0.3 (0.7)	1.3 (79.33)	PRE516FR	NPRES16FR
<i>(2) 200/346 V - 240/415 Vac 50/60 Hz</i>					
480/500 Vac 50/60 Hz – Black					
Wall Socket		1.5 (3.3)	4.7 (286.81)	PRE416RN	NPRES16RN
Plug		0.2 (0.4)	0.6 (36.61)	PRE416PN	NPRES16PN
Mobile Socket		0.6 (1.3)	4.0 (244.09)	PRE416MN	NPRES16MN
Flush Socket		0.3 (0.7)	1.3 (79.33)	PRE416FN	NPRES16FN
50/500 Vac 300/500 Hz – Green					
Wall Socket		1.6 (3.5)	4.7 (286.81)	PRE516RG	NPRES16RG
Plug		0.2 (0.4)	0.6 (36.61)	PRE516PG	NPRES16PG
Mobile Socket		0.6 (1.3)	4.0 (244.09)	PRE516MG	NPRES16MG
Flush Socket		0.3 (0.7)	1.3 (79.33)	PRE516FG	NPRES16FG



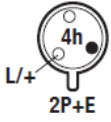
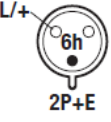
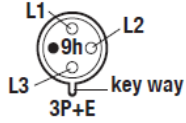
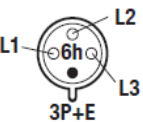





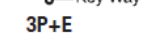

All technical data is relevant at the time of print.

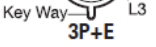
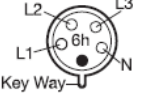
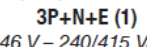
MODEL CODE / 32A

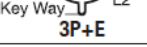
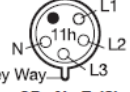
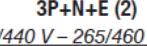
Description	Pin Configuration	Weight kg (lb)	Volume dm ³ (in ³)	Catalog Number		
				IECEX	NBR	
100/130 Vac 50/60 Hz – Yellow						
Wall Socket		1.9 (4.19)	7.0 (427.17)	PRE332RY	NPRE332RY	
Plug		0.5 (1.10)	4.0 (244.09)	PRE332PY	NPRE332PY	
Mobile Socket		0.8 (1.76)	3.2 (195.28)	PRE332MY	NPRE332MY	
Flush Socket		0.6 (1.32)	2.7 (164.76)	PRE332FY	NPRE332FY	
200/250 Vac 50/60 Hz – Blue						
Wall Socket		1.9 (4.19)	7.0 (427.17)	PRE332RB	NPRE332RB	
Plug		0.5 (1.10)	4.0 (244.09)	PRE332PB	NPRE332PB	
Mobile Socket		0.8 (1.76)	3.2 (195.28)	PRE332MB	NPRE332MB	
Flush Socket		0.6 (1.32)	2.7 (164.76)	PRE332FB	NPRE332FB	
Wall Socket		1.9 (4.19)	7.0 (427.17)	PRE432RB	NPRE432RB	
Plug		0.5 (1.10)	4.0 (244.09)	PRE432PB	NPRE432PB	
Mobile Socket		0.8 (1.76)	3.2 (195.28)	PRE432MB	NPRE432MB	
Flush Socket		0.6 (1.32)	2.7 (164.76)	PRE432FB	NPRE432FB	
Wall Socket		1.9 (4.19)	7.0 (427.17)	PRE532RB	NPRE532RB	
Plug		0.5 (1.10)	4.0 (244.09)	PRE532PB	NPRE532PB	
Mobile Socket		3P+N+E (1)	1.0 (2.20)	4.0 (244.09)	PRE532MB	NPRE532MB
Flush Socket		(1) 120/208 V - 144/250 Vac 50/60 Hz	0.6 (1.32)	2.7 (164.76)	PRE532FB	NPRE532FB
380/415 Vac 50/60 Hz – Red						
Wall Socket		2.0 (4.41)	7.0 (427.17)	PRE432RR	NPRE432RR	
Plug		0.4 (0.88)	4.0 (244.09)	PRE432PR	NPRE432PR	
Mobile Socket		0.8 (1.76)	3.2 (195.28)	PRE432MR	NPRE432MR	
Flush Socket		0.6 (1.32)	2.7 (164.76)	PRE432FR	NPRE432FR	
Wall Socket		2.0 (4.41)	7.0 (427.17)	PRE532RR	NPRE532RR	
Plug		0.5 (1.10)	4.0 (244.09)	PRE532PR	NPRE532PR	
Mobile Socket		3P+N+E (2)	1.0 (2.20)	4.0 (244.09)	PRE532MR	NPRE532MR
Flush Socket		(2) 200/346 V - 240/415 Vac 50/60 Hz	0.6 (1.32)	2.7 (164.76)	PRE532FR	NPRE532FR
480/500 Vac 50/60 Hz – Black						
Wall Socket		2.0 (4.41)	7.0 (427.17)	PRE432RN	NPRE432RN	
Plug		0.4 (0.88)	4.0 (244.09)	PRE432PN	NPRE432PN	
Mobile Socket		1.0 (2.20)	4.0 (244.09)	PRE432MN	NPRE432MN	
Flush Socket		0.6 (1.32)	2.7 (164.76)	PRE432FN	NPRE432FN	

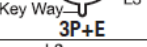
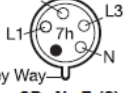
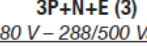
Plugs and sockets

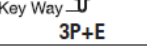
MODEL CODE / 63A

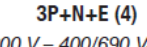
Description	Pin Configuration	Weight kg (lb)	Volume dm ³ (in ³)	Catalog Number	
				IECEX	NBR
200/250 Vac 50/60 Hz – Blue					
Wall Socket		8.0 (17.64)	26.0 (1586.62)	PRE463RBU5	NPRE463RBU5
Plug		1.0 (2.20)	7.0 (427.17)	PRE463PB	NPRE463PB
380/415 Vac 50/60 Hz – Red					
Wall Socket		8.0 (17.64)	26.0 (1586.62)	PRE463RRU5	NPRE463RRU5
Plug		1.0 (2.20)	7.0 (427.17)	PRE463PR	NPRE463PR
Wall Socket		8.0 (17.64)	26.0 (1586.62)	PRE563RRU5	NPRE563RRU5
Plug		1.0 (2.20)	7.0 (427.17)	PRE563PR	NPRE563PR
<i>(1) 200/346 V – 240/415 Vac 50/60 Hz</i>					
440/460 Vac 60 Hz – Red					
Wall Socket		8.0 (17.64)	26.0 (1586.62)	PRE463RR1U5	NPRE463RR1U5
Plug		1.0 (2.20)	7.0 (427.17)	PRE463PR1	NPRE463PR1
Wall Socket		8.0 (17.64)	26.0 (1586.62)	PRE563RR1U5	NPRE563RR1U5
Plug		1.0 (2.20)	7.0 (427.17)	PRE563PR1	NPRE563PR1
<i>(2) 250/440 V – 265/460 Vac 60 Hz</i>					
480/500 Vac 50/60 Hz – Black					
Wall Socket		8.0 (17.64)	26.0 (1586.62)	PRE463RNU5	NPRE463RNU5
Plug		1.0 (2.20)	7.0 (427.17)	PRE463PN	NPRE463PN
Wall Socket		8.0 (17.64)	26.0 (1586.62)	PRE563RNU5	NPRE563RNU5
Plug		1.0 (2.20)	7.0 (427.17)	PRE563PN	NPRE563PN
<i>(3) 277/480 V – 288/500 Vac 50/60 Hz</i>					
600/690 Vac 50/60 Hz – Black					
Wall Socket		8.0 (17.64)	26.0 (1586.62)	PRE463RN1U5	NPRE463RN1U5
Plug		1.0 (2.20)	7.0 (427.17)	PRE463PN1	NPRE463PN1
Wall Socket		8.0 (17.64)	26.0 (1586.62)	PRE563RN1U5	NPRE563RN1U5
Plug		1.0 (2.20)	7.0 (427.17)	PRE563PN1	NPRE563PN1
<i>(4) 347/600 V – 400/690 Vac 50/60 Hz</i>					

DIMENSION / 16A

16A – 2P – 2P+E – 3P Versions

Wall Mounting Sockets

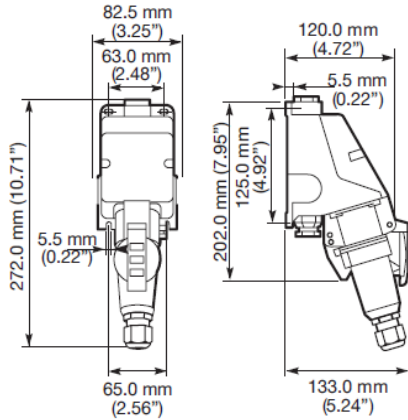

Plugs

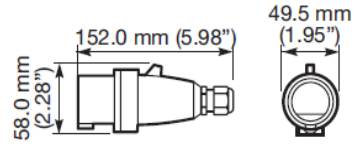

Mobile Sockets

Can be mounted on panel - 0.12"/3.0 mm thickness maximum

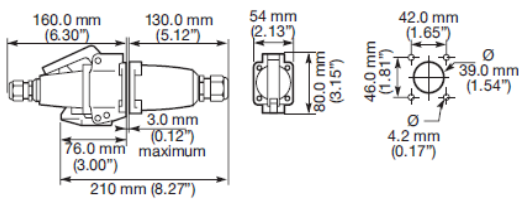

Flush Sockets

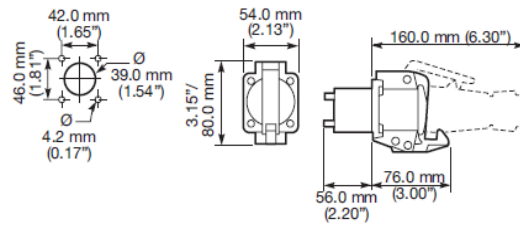

16A – 3P+E – 3P+N+E Versions

Wall Mounting Sockets

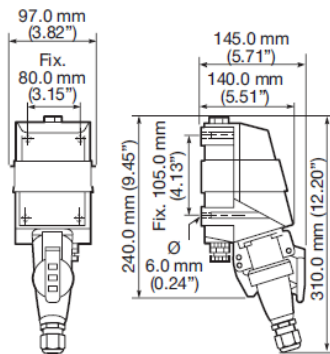

Plugs

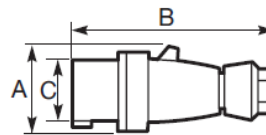

Dimensions in Millimeters (Inches)			
	A	B	C
3 P + E	66.0 (2.60)	154.0 (6.06)	55.5 (2.19)
3 P + N + E	73.0 (2.87)	166.0 (6.54)	62.0 (2.44)

Mobile Sockets

Can be mounted on panel - 3.0 mm (0.12") thickness maximum

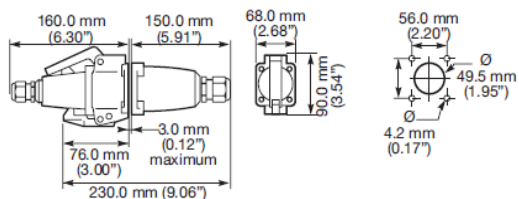

Flush Sockets

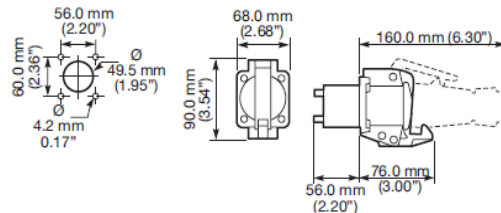

DIMENSION / 32A

32A – 2P+E – 3P+E – 3P+N+E Versions

Wall Mounting Sockets

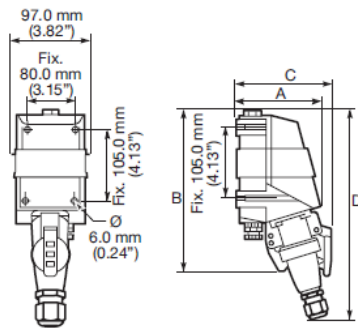

Plugs

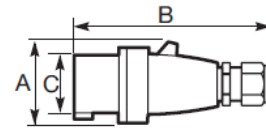

Dimensions in Millimeters (Inches)				
	A	B	C	D
2 P + E	140.0 (5.51)	275.0 (10.83)	155.0 (6.10)	370.0 (14.67)
3 P + E	140.0 (5.51)	275.0 (10.83)	155.0 (6.10)	370.0 (14.67)
3 P + N + E	140.0 (5.51)	275.0 (10.83)	165.0 (6.50)	375.0 (14.76)

Dimensions in Millimeters (Inches)			
	A	B	C
2 P + T	80.0 (3.15)	170.0 (6.69)	67.0 (2.64)
3 P + T	80.0 (3.15)	170.0 (6.69)	67.0 (2.64)
3 P + N + T	80.0 (3.15)	195.0 (7.68)	74.0 (2.91)

Mobile Sockets

Can be mounted on panel - 3.0 mm (0.12") thickness maximum

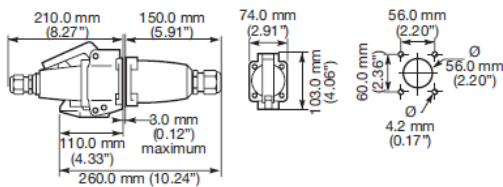

Flush Sockets

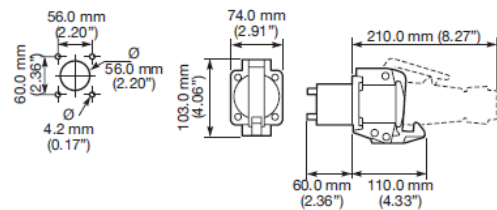

DIMENSION / 63A

